

1

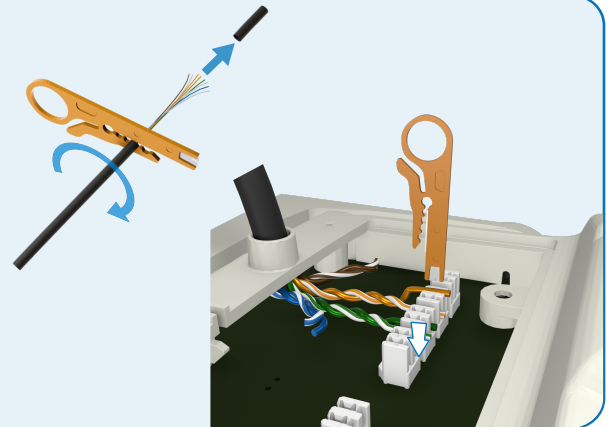

<https://senstar.com/product-resources/multisensor-help>

2

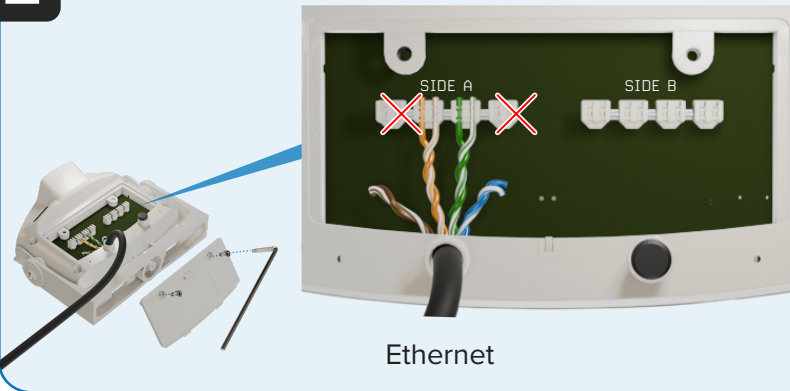

3

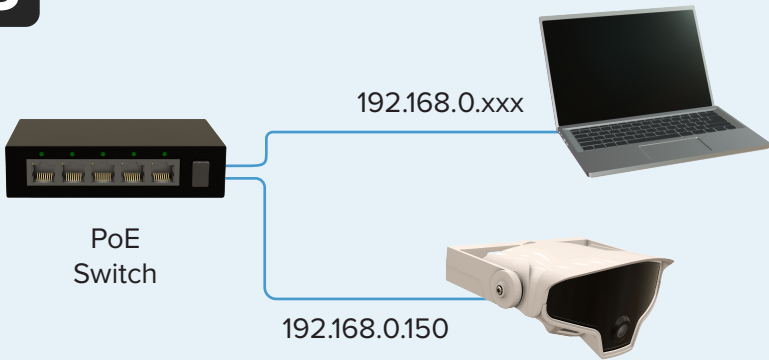

4

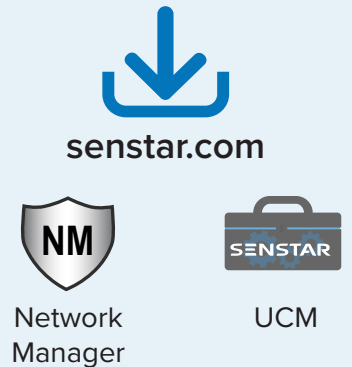

5

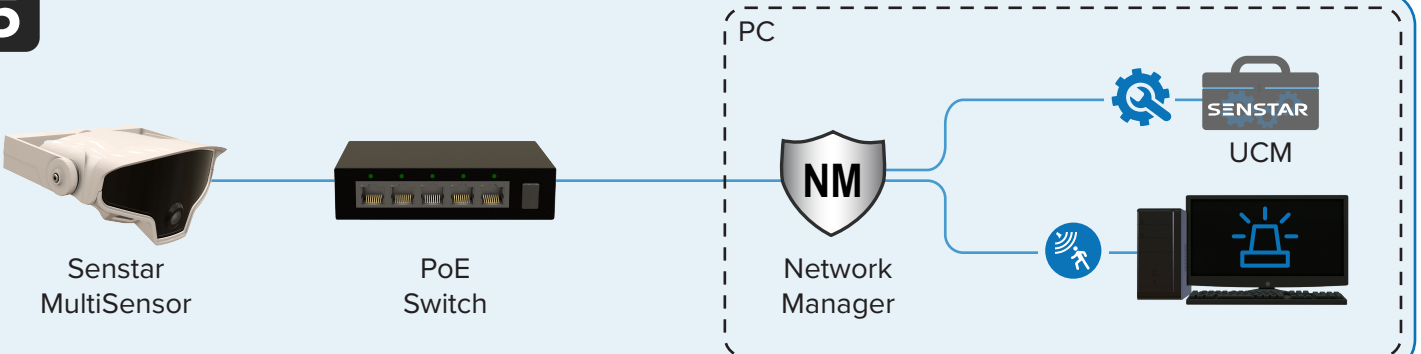

6

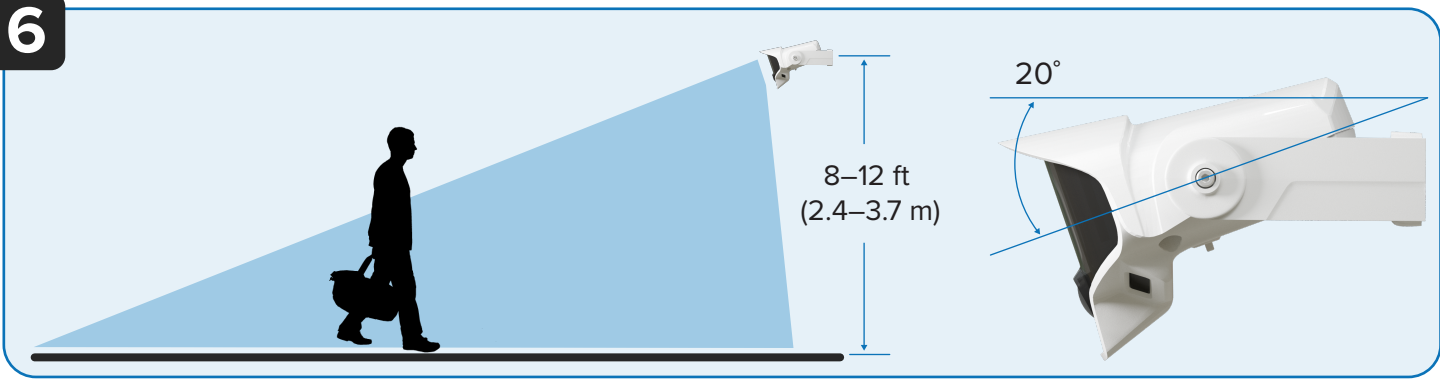

7

Network Manager Setup

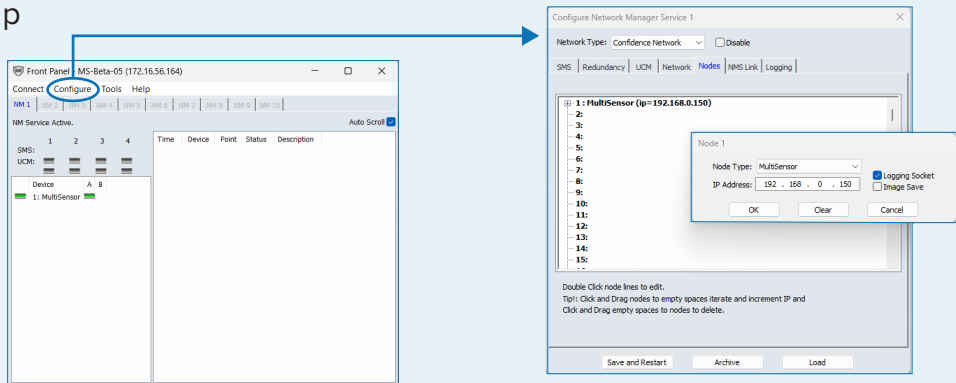

8

UCM Configuration (Height)

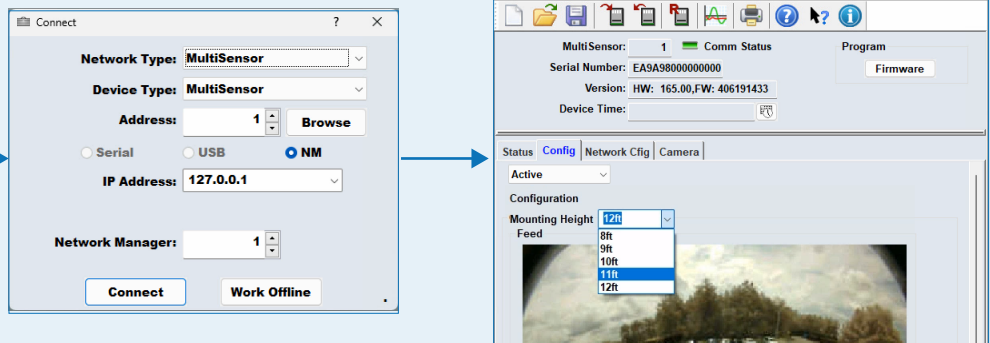

9

UCM Configuration (Detection Zone)

